INSTALLATION INSTRUCTIONS

Wall Mount Energy Recovery Ventilator with Exhaust

Models:

ERV-FA5 ERV-FC5 ERV-FT5

For Use with Bard Wall Mount
Air Conditioner and Heat Pump Models:

W3SAC, W4SAC, W5SAC
W42AC, W48AC, W60AC, W72AC
W42AY, W48AY, W60AY, W72AY
W42HC, W48HC, W60HC
W42HY, W48HY, W60HY
W3VHY, W5VHY
C36HY, C42HY, C48HY, C60HY

NOTE: *It is highly recommended that this ERV is installed into the unit **prior** to mounting the unit to the wall for improved access to fasteners.*



Climate Control Solutions

Bard Manufacturing Company, Inc.
Bryan, Ohio 43506
www.bardhvac.com

Manual: 2100-699F
Supersedes: 2100-699E
Date: 12-7-23

CONTENTS

General Information	3
Energy Recovery Ventilator Model Nomenclature	3
Unpacking.....	3
Description	3
Electrical Specifications.....	4
General	4
Performance and Application Data – ERV-F*5	5
Installation of Field-Installed ERV-F*5.....	6
Basic Installation	6
Control Wiring.....	17
Control Requirements.....	17
Recommended Control Sequences.....	18
Ventilation Airflow	18
Energy Recovery Ventilator Maintenance.....	20
General Information.....	20
Frequency.....	20
Cleanability and Performance	20
Maintenance Procedures	20
Quarterly Maintenance.....	20
Annual Maintenance.....	21

FIGURES

Figure 1	Disconnect Power	6
Figure 2	Remove Four Panels.....	6
Figure 3	Remove Low Voltage Control Panel	6
Figure 4	Remove Blank Off Covers.....	7
Figure 5	Remove Exhaust Blank Off Plate	7
Figure 6	Remove Screws from Condenser Section.....	7
Figure 7	Remove Screw from Condenser Partition Insert.....	7
Figure 8	Remove Screws from Condenser Partition Insert	8
Figure 9	Remove Screws from Sides of Condenser Partition Insert.....	8
Figure 10	Remove Screws from Under Control Panel in Exhaust.....	8
Figure 11	Remove Condenser Partition Insert	8
Figure 12	Unit Ready for ERV Installation	9
Figure 13	Install Exhaust Blower Base	9
Figure 14	Install Exhaust Blower Assembly Inside Base	9
Figure 15	Install Front Cassette Mounting Rail	9
Figure 16	Install Center Cassette Rack.....	9
Figure 17	Insert Screws Through Condenser Section into Center Cassette Rack	9
Figure 18	Install Exhaust Blower Male Plug.....	10
Figure 19	Install Exhaust Blower Female Plug	10
Figure 20	Bundle Wires with Zip Tie	10
Figure 21	Run Harness Wires Across Unit and Fasten to Existing Wires.....	10
Figure 22	Run Harness Wires Through Opening	11
Figure 23	Remove Two Wire Channel Covers.....	11
Figure 24	Install ERV Control Board Assembly.....	11
Figure 25	Route Exhaust Blower Wires to ERV Control Board Assembly.....	11
Figure 26	Connect White Wire to Terminal Block.....	12
Figure 27	Insert Plugs into Proper Spots for Desired Speeds.....	12
Figure 28	Install Rear ERV Mounting Rail	12

Figure 29	Install Additional Screws into Rear ERV Mounting Rail.....	12
Figure 30	Slide Cassette Frame into Mounting Rails..	13
Figure 31	Cassettes Installed Properly into Cassette Rack and Cassette Mounting Rail ..	13
Figure 32	Slide Upper Blower Assembly Over Cassettes	13
Figure 33	Upper Blower Assembly Over Cassettes.....	13
Figure 34	Exhaust Blower, Cassettes and Upper Blower Assembly Installed Properly.....	14
Figure 35	Install 4-Pin Female Plug and Connect White Wire	14
Figure 36	Connect Male Plug to Female Plug	14
Figure 37	Route Red and Black Wires to Compressor Contactor (Non-W*VHY Models)	14
Figure 38	Route Red and Black Wires (W*VHY Models)	15
Figure 39	ERV Relay Com and 24 Wire(s) (W*VHY Models)	15
Figure 40	ERV Relay Com Wire Landing (W*VHY Models)	15
Figure 41	Connect Cassette Wire Harnesses and Ground Wires.....	15
Figure 42	Route First Wire Harness Wires Up into Control Panel.....	15
Figure 43	Connect Wires to Capacitor and Terminal Block.....	16
Figure 44	Cassette Seal Adjustment Angle	16
Figure 45	Loosen Screws to Adjust Pile Seal	16
Figure 46	Install Upper Side Covers.....	16
Figure 47	Install Lower Side Covers.....	17
Figure 48	Install Bug Screen and Gaskets	17
Figure 49	Speed Tap Label	18
Figure 50	Airflow Diagram	19
Figure 51	Belt Replacement Instructions	21
Figure 52	Hub Assembly with Ball Bearings	22
Figure 53	Wire Routings (Non-W*VHY Models)	23
Figure 54	Wire Routings (W*VHY Models)	24
Figure 55	Transformer Routing and Wire Routing (ERV-FC5 460V Only)	25
Figure 56	Transformer Routing and Wire Routing (ERV-FT5 460V Only).....	26
Figure 57	ERV-FA5 230V Wiring Diagram (Non-W*VHY Models)	27
Figure 58	ERV-FA5 230V Wiring Diagram (W*VHY Models)	28
Figure 59	ERV-FC5 460V Wiring Diagram (Non-W*VHY Models)	29
Figure 60	ERV-FA5 460V Wiring Diagram (Non-W*VHY Models)	30
Figure 61	ERV-FT5 460V Wiring Diagram (W*VHY Models)	31

TABLE

Table 1	Wall-Mount Unit Reference Table.....	4
Table 2	Ventilation Air (CFM)	17

Energy Recovery Ventilator Model Nomenclature

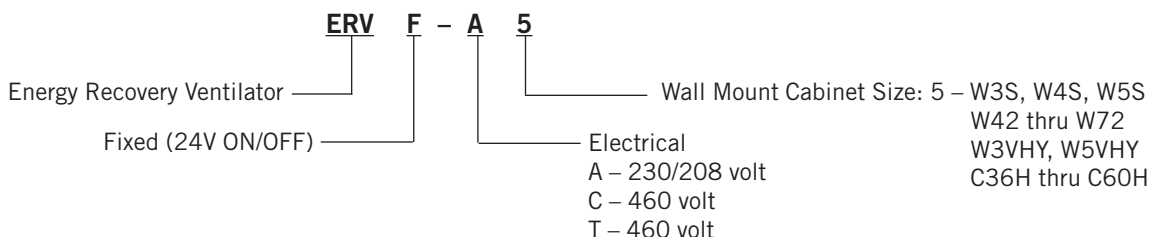

Unpacking

Upon receipt of the equipment, be sure to compare the model number found on the shipping label with the accessory identification information on the ordering and shipping document to verify that the correct accessory has been shipped.

Inspect the carton housing of each ventilator as it is received and, before signing the freight bill, verify that all items have been received and that there is no visible damage. Note any shortages or damage on all copies of the freight bill. The receiving party must contact the last carrier immediately, preferably in writing, requesting inspection by the carrier's agent. Concealed damage not discovered until after loading must be reported to the carrier within 15 days of its receipt.

Description

The energy recovery ventilator was designed to provide energy efficient, cost effective ventilation to meet IAQ (Indoor Air Quality) requirements while still maintaining good indoor comfort and humidity control for a variety of applications such as schools, classrooms, lounges, conference rooms, beauty salons and others. It provides a constant supply of fresh air for control of airborne pollutants including CO₂, smoke, radon, formaldehyde, excess moisture, virus and bacteria.

The ventilator incorporates rotary heat exchanger technology to remove both heat and moisture.

It is designed as a single package which can be easily factory or field installed. The package consists of a unique rotary energy recovery cassette that can be easily removed for cleaning or maintenance. The ERV-F*5 has two 13" diameter heat transfer wheels. The heat transfer wheels use a permanently bonded dry desiccant coating for total heat recovery.

Ventilation is accomplished with two blower/motor assemblies each consisting of a drive motor and dual blowers for maximum ventilation at low sound levels. The intake and exhaust blowers can be operated at the same speed (airflow rate) or different speeds to allow flexibility in maintaining desired building pressurization conditions.

Factory shipped on medium intake and low exhaust. See **Ventilation Airflow** on page 18 for information on changing speeds. The rotating energy wheels provide the heat transfer effectively during both summer and winter conditions. Provide required ventilation to meet the requirements of ASHRAE 62.1 standard.

NOTE: During operation below 5°F outdoor temperature, freezing of moisture in the heat transfer wheel can occur. Consult the factory if this possibility exists.

CAUTION

Be sure the correct model and voltage energy recovery ventilator is used with the correct air conditioner or heat pump to ensure correct voltage compatibility.

**TABLE 1
Wall-Mount Reference Table**

Model	For Use with the Following Units		Electrical	Wiring Diagram
ERV-FA5	W3SAC-A, -B W4SAC-A, -B W5SAC-A, -B W42A*-A, -B W48A*-A, -B W60A*-A, -B W72A*-A, -B	W42H*-A, -B W48H*-A, -B W60H*-A, -B C36HY-A, -B C42HY-A, -B C48HY-A, -B C60HY-A, -B	230/208V 1 or 3 phase	4056-249
ERV-FC5	W3SAC-C W4SAC-C W5SAC-C W42A*-C W48A*-C W60A*-C W72A*-C	W42H*-C W48H*-C W60H*-C	460V 3 phase	4056-317
ERV-FA5	--	C36HY-C C42HY-C C48HY-C C60HY-C	460V 3 phase*	4056-272
ERV-FA5	--	W3VHY-R, S W5VHY-R, S	230/208V 1 or 3 phase	4056-268
ERV-FT5	--	W3VHY-T W5VHY-T	460V 3 phase	4056-277

* Must be wired to unit's existing step down transformer. Reference unit and vent wiring diagrams.

Electrical Specifications

Model	Voltage	Amps	Control Voltage
ERV-FA5	230/208	2.2	24V
ERV-FC5	460	1.2	24V
ERV-FT5*	230	2.2	24V

* Connected to stepdown transformer

General

The ventilator should only be installed by a trained heating and air conditioning technician. These instructions serve as a guide to the technician installing the ventilator package. They are not intended as a step-by-step procedure with which the mechanically inclined owner can install the package.

The ERV is shipped in one carton which contains the following:

ERV-F-A5 (230V)

- (1) 920-0454 ERVF upper blower assembly
- (1) 920-0456 ERVF cassette assembly
- (1) 920-0457 ERVF lower blower assembly
- (20) 1012-086 screw type AB HXWHD#10-16X1/2
- (1) 1012-153 screw type AB HXWSHD#10-16X1/2
- (4) 1012-065 screw type AB PZPNHD #8-18x3/8
- (1) 910-2066 ERVF-A5 control board assembly
- (2) 3000-1631 wire assembly
- (1) 3000-1632 wire assembly
- (1) 3018-2175 36" black wire with ferrule end
- (1) 3018-2176 36" red wire with ferrule end
- (1) 3018-2433 32" black wire with quick connects
- (1) 8611-125-3300 33" of 1/2" split tubing
- (2) 7950-004 cable ties 7" ladder
- (2) 7950-006 nylon cable clamp 1/2"
- (1) 543X224 upper side cover assembly – RH
- (1) 543Y224 upper side cover assembly – LH
- (1) 543X225 lower side cover assembly – RH
- (1) 543Y225 lower side cover assembly – LH
- (1) 121-589 condenser partition ERV insert
- (1) 541-500 rear ERV mounting rail assembly
- (1) 141-501 front ERV mounting rail
- (1) 521-590 cassette support partition assembly
- (1) 7003-083 exhaust bug screen
- (2) 1913-002-0808 foam strips
- (1) 4056A249 wiring diagram
- (1) 4056A268 wiring diagram
- (1) 2100-699F installation instructions

ERV-F-C5 (460V)

Includes all of the above 230V (where applicable) plus:

- (49) 1012-086 screw type AB HXWHD#10-16X1/2
- (2) 1012-153 screw type AB HXWSHD#10-16X1/2
- (1) 910-2068 ERVF-C5 control board assembly
- (1) 3000-1634 wire assembly
- (1) 910-2074 transformer assembly
- (4) 7950-004 cable ties 7" ladder
- (1) 7950-012 push mount cable tie 6-1/8"
- (1) 4056A317 wiring diagram

ERV-F-T5 (460V)

Includes all of the above 230V (where applicable) plus:

- (49) 1012-086 screw type AB HXWHD#10-16X1/2
- (2) 1012-153 screw type AB HXWSHD#10-16X1/2
- (1) 910-2209 ERVF-T5 control board assembly
- (1) 3000-1634 wire assembly
- (1) 3018-2177 39" black wire with ferrule end
- (1) 3018-2178 35" red wire with ferrule end
- (1) 3018-2433 32" black wire with quick connects
- (1) 910-2209 transformer assembly
- (4) 7950-004 cable ties 7" ladder
- (1) 7950-012 push mount cable tie 6-1/8"
- (1) 4056A277 wiring diagram

PERFORMANCE AND APPLICATION DATA – ERV-F*5

Summer Cooling Performance (Indoor Design Conditions 75°DB/62°WB)

Ambient O.D.		VENTILATION RATE 450 CFM 65% EFFICIENCY						VENTILATION RATE 375 CFM 66% EFFICIENCY						VENTILATION RATE 300 CFM 67% EFFICIENCY					
DB/WB	F	VLT	VLS	VLL	HRT	HRS	HRL	VLT	VLS	VLL	HRT	HRS	HRL	VLT	VLS	VLL	HRT	HRS	HRL
105	75	21465	14580	6884	13952	9477	4475	17887	12150	5737	11805	8018	3786	14310	9720	4590	9587	6512	3075
	70	14580	14580	0	9477	9477	0	12150	12150	0	8018	8018	0	9720	9720	0	6512	6512	0
	65	14580	14580	0	9477	9477	0	12150	12150	0	8018	8018	0	9720	9720	0	6512	6512	0
100	80	31590	12150	19440	20533	7897	12635	26325	10125	16200	17374	6682	10692	21060	8100	12960	14110	5427	8683
	75	21465	12150	9314	13952	7897	6054	17887	10125	7762	11805	6682	5123	14310	8100	6210	9587	5427	4160
	70	12352	12150	202	8029	7897	131	10293	10125	168	6793	6682	111	8235	8100	135	5517	5427	90
	65	12150	12150	0	7897	7897	0	10125	10125	0	6682	6682	0	8100	8100	0	5427	5427	0
	60	12150	12150	0	7897	7897	0	10125	10125	0	6682	6682	0	8100	8100	0	5427	5427	0
95	80	31590	9720	21870	20533	6318	14215	26325	8100	18225	17374	5345	12028	21060	6480	14580	14110	4341	9768
	75	21465	9720	11744	13952	6318	7634	17887	8100	9787	11805	5345	6459	14310	6480	7830	9587	4341	5246
	70	12352	9720	2632	8029	6318	1711	10293	8100	2193	6793	5345	1447	8235	6480	1755	5517	4341	1175
	65	9720	9720	0	6318	6318	0	8100	8100	0	5345	5345	0	6480	6480	0	4341	4341	0
	60	9720	9720	0	6318	6318	0	8100	8100	0	5345	5345	0	6480	6480	0	4341	4341	0
90	80	31590	7290	24300	20533	4738	15794	26325	6075	20250	17374	4009	13365	21060	4860	16200	14110	3256	10854
	75	21465	7290	14175	13952	4738	9213	17887	6075	11812	11805	4009	7796	14310	4860	9450	9587	3256	6331
	70	12352	7290	5062	8029	4738	3290	10293	6075	4218	6793	4009	2784	8235	4860	3375	5517	3256	2261
	65	7290	7290	0	4738	4738	0	6075	6075	0	4009	4009	0	4860	4860	0	3256	3256	0
	60	7290	7290	0	4738	4738	0	6075	6075	0	4009	4009	0	4860	4860	0	3256	3256	0
85	80	31590	4860	26730	20533	3159	17374	26325	4050	22275	17374	2672	14701	21060	3240	17820	14110	2170	11939
	75	21465	4860	16605	13952	3159	10793	17887	4050	13837	11805	2672	9132	14310	3240	11070	9587	2170	7416
	70	12352	4860	7492	8029	3159	4870	10293	4050	6243	6793	2672	4120	8235	3240	4995	5517	2170	3346
	65	4860	4860	0	3159	3159	0	4050	4050	0	2672	2672	0	3240	3240	0	2170	2170	0
	60	4860	4860	0	3159	3159	0	4050	4050	0	2672	2672	0	3240	3240	0	2170	2170	0
80	75	21465	2430	19035	13952	1579	12372	17887	2025	15862	11805	1336	10469	14310	1620	12690	9587	1085	8502
	70	12352	2430	9922	8029	1579	6449	10293	2025	8268	6793	1336	5457	8235	1620	6615	5517	1085	4432
	65	4252	2430	1822	2764	1579	1184	3543	2025	1518	2338	1336	1002	2835	1620	1215	1899	1085	814
	60	2430	2430	0	1579	1579	0	2025	2025	0	1336	1336	0	1620	1620	0	1085	1085	0
75	70	12352	0	12352	8029	0	8029	10293	0	10293	6793	0	6793	8235	0	8235	5517	0	5517
	65	4252	0	4252	2764	0	2764	3543	0	3543	2338	0	2338	2835	0	2835	1899	0	1899
	60	0	0	0	0	0	0	0	0	0	0	0	0	0	0	0	0	0	0

Winter Heating Performance (Indoor Design Conditions 70°F DB)

Ambient O.D.	VENTILATION RATE					
	450 CFM 80% EFFICIENCY		375 CFM 81% EFFICIENCY		300 CFM 82% EFFICIENCY	
DB/°F	WVL	WHR	WVL	WHR	WVL	WHR
65	2430	1944	2025	1640	1620	1328
60	4860	3888	4050	3280	3240	2656
55	7290	5832	6075	4920	4860	3985
50	9720	7776	8100	6561	6480	5313
45	12150	9720	10125	8201	8100	6642
40	14580	11664	12150	9841	9720	7970
35	17010	13608	14175	11481	11340	9298
30	19440	15552	16200	13122	12960	10627
25	21870	17496	18225	14762	14580	11955
20	24300	19440	20250	16402	16200	13284
15	26730	21384	22275	18042	17820	14612

LEGEND:

- VLT = Ventilation Load - Total
- VLS = Ventilation Load - Sensible
- VLL = Ventilation Load - Latent
- HRT = Heat Recovery - Total
- HRS = Heat Recovery - Sensible
- HRL = Heat Recovery - Latent
- WVL = Winter Ventilation Load
- WHR = Winter Heat Recovery

NOTE: All performance data is based on operating intake and exhaust blower on the same speed.

INSTALLATION OF FIELD-INSTALLED ERV-F*5

Basic Installation

NOTE: It is highly recommended that this ERV is installed into the unit **prior** to mounting the unit to the wall for improved access to fasteners.

WARNING

Electrical shock hazard.
Disconnect remote electrical power supply or supplies before servicing.
Failure to do so could result in electric shock or death.

WARNING

Exposed moving parts.
Disconnect electrical power before servicing.
Failure to do so could result in severe injury or amputation.

CAUTION

Cut hazard.
Wear gloves to avoid contact with sharp edges.
Failure to do so could result in personal injury.

NOTE: Save all screws during the removal process as they will be used for the ERV installation.

Disconnect all power to unit at the disconnect access door (see Figure 1).

FIGURE 1
Disconnect Power



IMPORTANT: Sheet metal has sharp edges. The use of personal protective equipment (PPE) is required.

Remove four (4) panels: Two (2) side grilles (one per side), one (1) control panel cover and one (1) front grille (see Figure 2).

FIGURE 2
Remove Four Panels

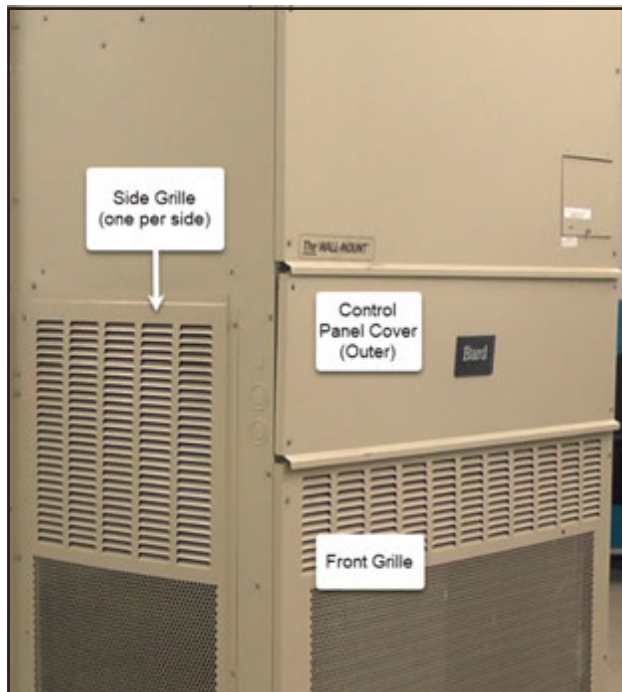

Remove the low voltage control panel (see Figure 3).

FIGURE 3
Remove Low Voltage Control Panel



Remove two (2) blank off covers (one on each side) and discard (see Figure 4).

FIGURE 4
Remove Blank Off Covers



Remove exhaust blank off plate through return or through side intake opening and discard (see Figure 5).

FIGURE 5
Remove Exhaust Blank Off Plate



Remove two (2) screws (one per side) in the condenser section (see Figure 6).

FIGURE 6
Remove Screws from Condenser Section

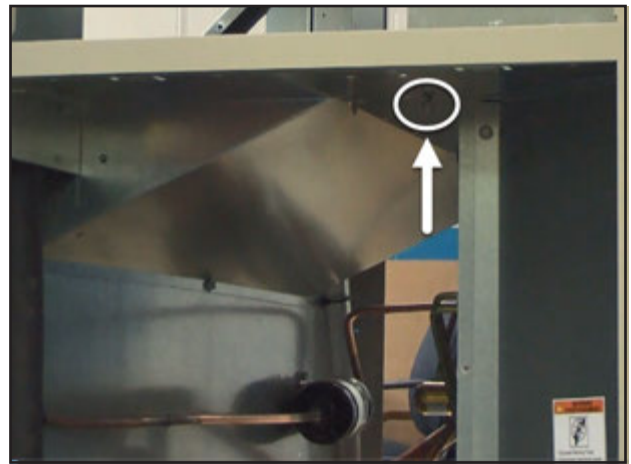

Remove one (1) screw from condenser partition insert (see Figure 7).

FIGURE 7
Remove Screw from Condenser Partition Insert



Remove screws from condenser partition insert (see Figure 8).

FIGURE 8
Remove Screws from Condenser Partition Insert

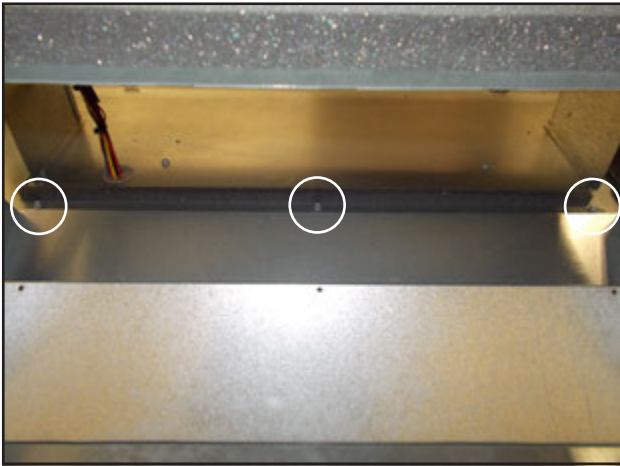

Remove two (2) screws (one per side) from the condenser partition insert (see Figure 9).

FIGURE 9
Remove Screws from Sides of Condenser Partition Insert



Remove two (2) screws (one per side) under the control panel in the exhaust (see Figure 10).

FIGURE 10
Remove Screws Under Control Panel in Exhaust

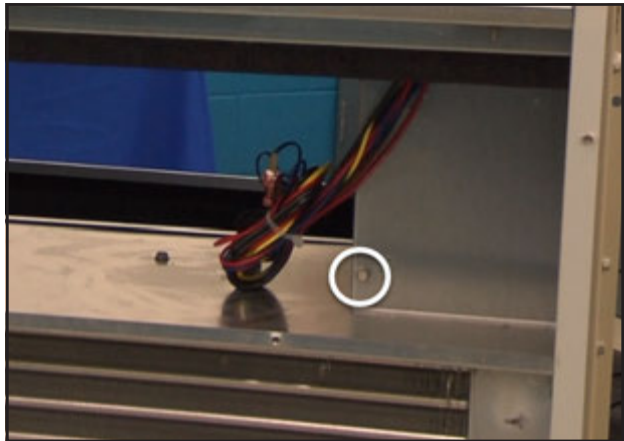

Remove condenser partition insert through condenser section (see Figure 11).

FIGURE 11
Remove Condenser Partition Insert



Once all of the necessary parts are removed, the unit should look as shown in Figure 12. The ERV is now ready to be installed.

FIGURE 12
Unit Ready for ERV Installation

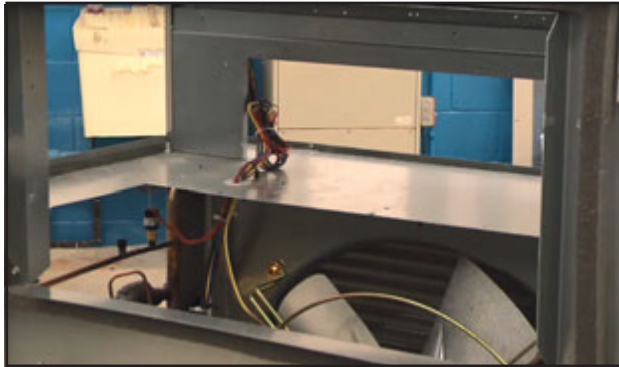

Begin by installing the exhaust blower base with two (2) screws (see Figure 13).

FIGURE 13
Install Exhaust Blower Base

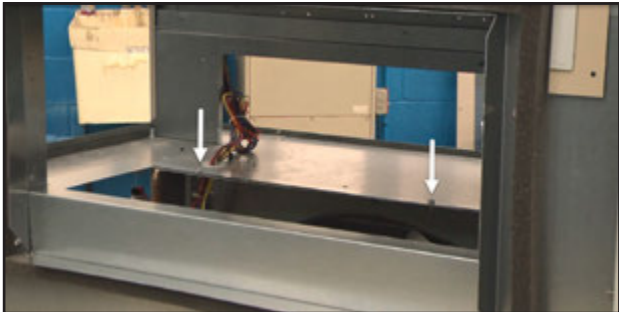

Install the exhaust blower assembly inside of the base using four (4) screws with the electrical at the right side (when looking at the back of the unit). See Figure 14.

FIGURE 14
Install Exhaust Blower Assembly Inside Base

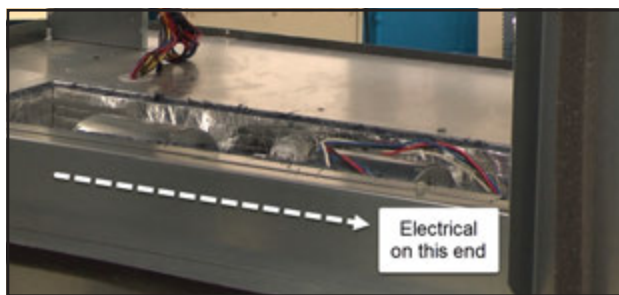

Install the front cassette mounting rail using three (3) screws. Ensure that the small flange is pointing upward when installing (see Figure 15).

FIGURE 15
Install Front Cassette Mounting Rail

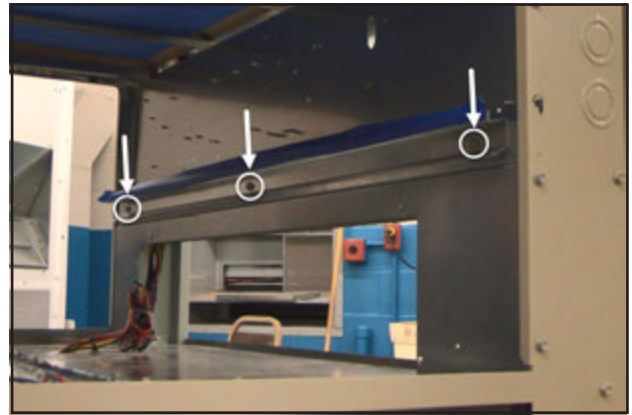

Install the center cassette rack using one (1) screw in the center (see Figure 16).

FIGURE 16
Install Center Cassette Rack



Insert two (2) screws (one per side) through the condenser section and into the center cassette rack (see Figure 17).

FIGURE 17
Insert Screws Through Condenser Section into Center Cassette Rack

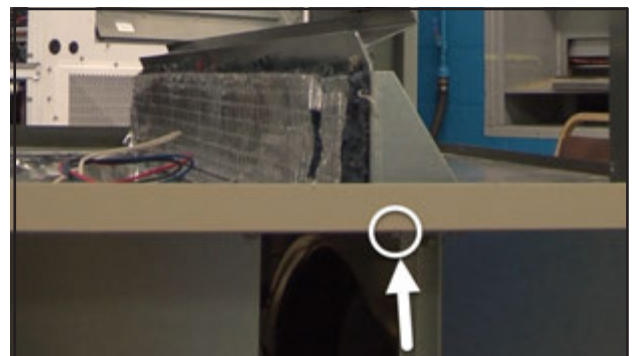

Install the exhaust blower 4-pin male plug into the opening in the center cassette rack (see Figure 18).

FIGURE 18
Install Exhaust Blower Male Plug

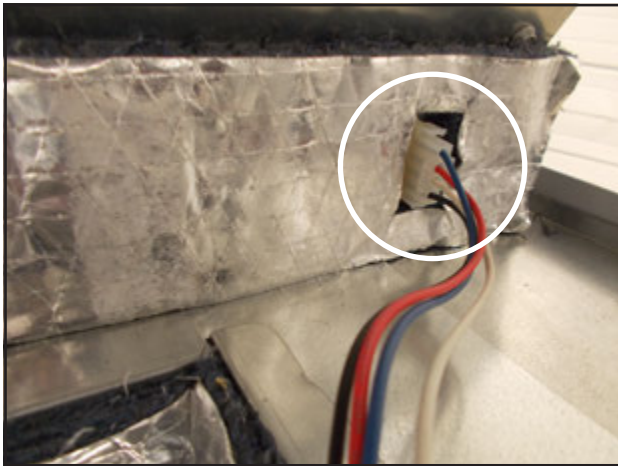

Install the 4-pin female plug for the exhaust blower (see Figure 19).

FIGURE 19
Install Exhaust Blower Female Plug

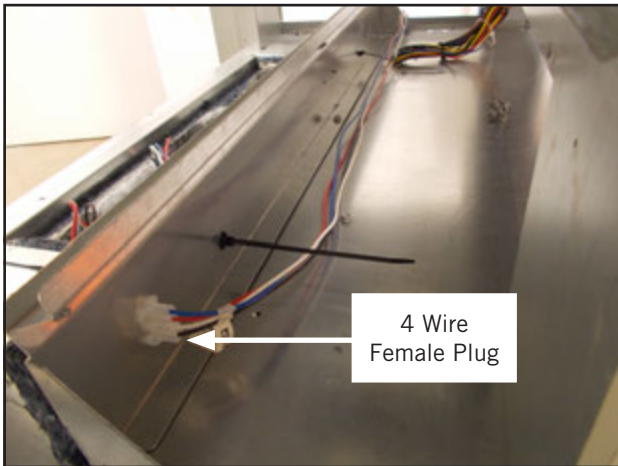

Bundle these wires with provided zip tie to ensure that they will not get caught in any moving parts (see Figure 20).

FIGURE 20
Bundle Wires with Zip Tie

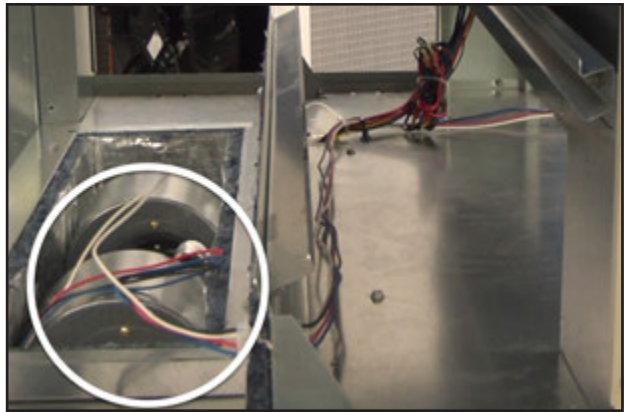

Run the harness wires across the unit and fasten them to the existing wires with a provided zip tie (see Figure 21).

FIGURE 21
Run Harness Wires Across Unit and Fasten to Existing Wires

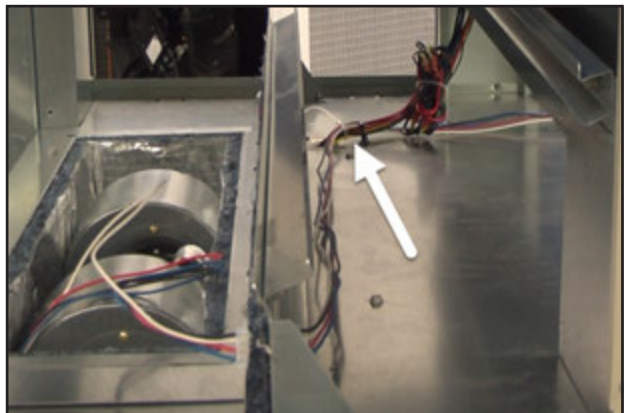

Run the harness wires through the opening beneath the compressor contactor (see Figure 22).

FIGURE 22
Run Harness Wires Through Opening

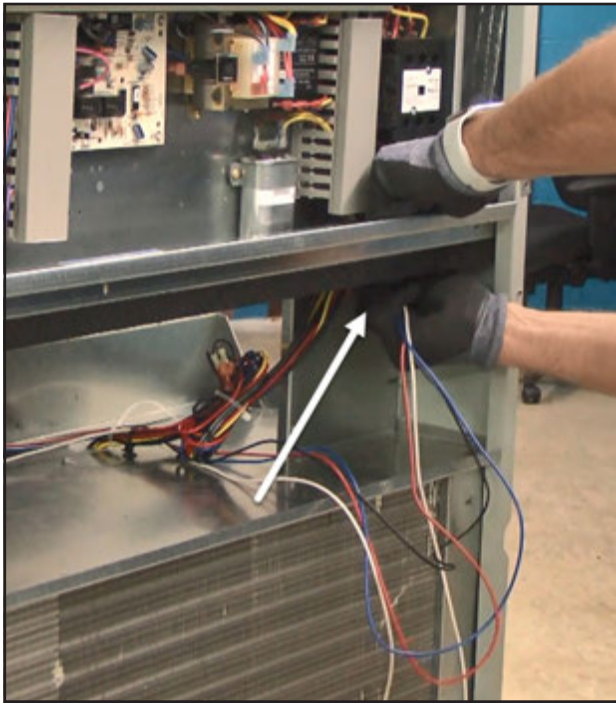

Remove two (2) wire channel covers (see Figure 23).

FIGURE 23
Remove Two Wire Channel Covers



Install the ERV control board assembly on the left side of the control panel using four (4) of the provided #8 18x3/8 screws. Connect the 12-pin male plug into the low voltage box (see Figure 24).

NOTE: 12-pin male plug not used in W*VHY models.

FIGURE 24
Install ERV Control Board Assembly

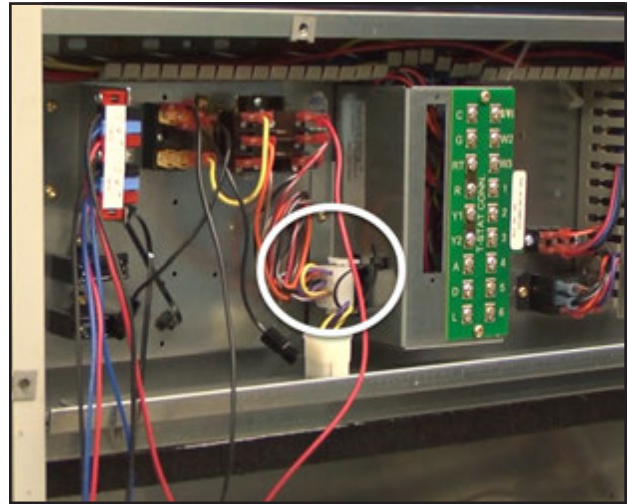

Route the exhaust blower wires through the wire channels and to the ERV control board assembly (see Figure 25). Connect each corresponding wire to the wire coming off of the exhaust speed tap.

FIGURE 25
Route Exhaust Blower Wires to ERV Control Board Assembly

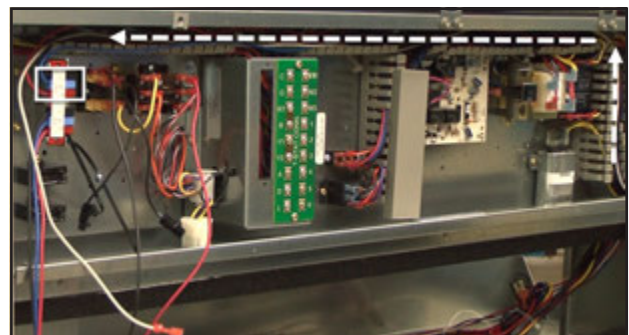

Following the wiring diagram, connect the white wire from the exhaust wire harness to the terminal block. Tuck any excess wire from the harness into the wire channel (see Figure 26).

FIGURE 26
Connect White Wire to Terminal Block

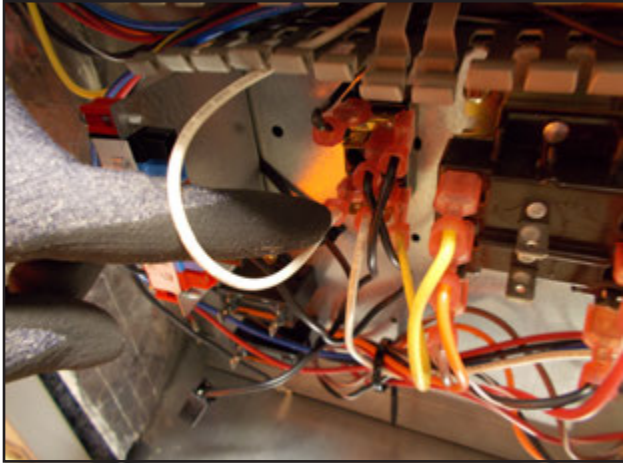

Insert each plug into the corresponding plug for the desired exhaust and intake speeds (see Figure 27).

FIGURE 27
Insert Plugs into Proper Spots for Desired Speeds

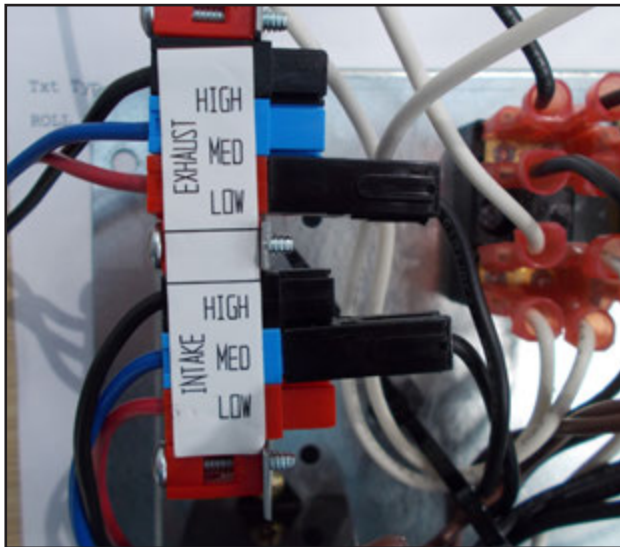

Install the rear ERV mounting rail using three (3) screws near the return flanges (see Figure 28).

FIGURE 28
Install Rear ERV Mounting Rail



Install two (2) more screws into the ERV mounting rail (one per side). See Figure 29.

FIGURE 29
Install Additional Screws into Rear ERV Mounting Rail



Insert cassettes by sliding the cassette frame into the front mounting rail and the rear ERV mounting rail (see Figure 30). Verify that the cassette belt wheel is towards the control panel for proper cassette operation. The cassettes should also slide in on the cassette support.

FIGURE 30
Slide Cassette Frame into Mounting Rails



Figure 31 shows the cassettes installed in the center cassette rack and the cassette mounting rail.

FIGURE 31
Cassettes Installed Properly into Cassette Rack and Cassette Mounting Rail



Slide in upper blower assembly on the front mounting rail over the cassettes (see Figure 32).

FIGURE 32
Slide Upper Blower Assembly Over Cassettes

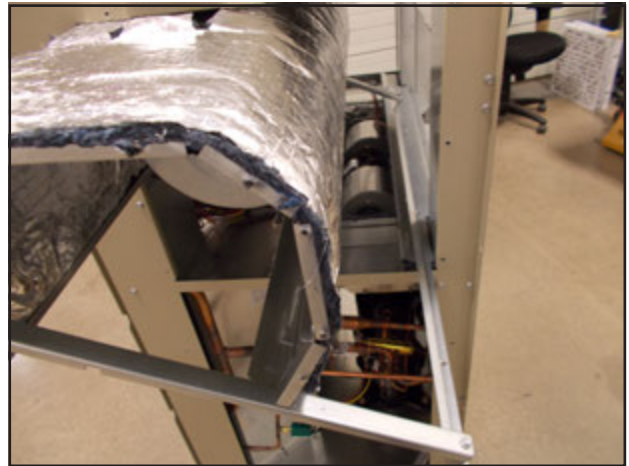

Upper blower assembly should slide over the cassettes without scraping them (as shown in Figure 33).

FIGURE 33
Upper Blower Assembly Over Cassettes



Figure 34 shows the exhaust blower, cassettes and upper blower assembly installed.

FIGURE 34
Exhaust Blower, Cassettes and Upper Blower Assembly Installed Properly

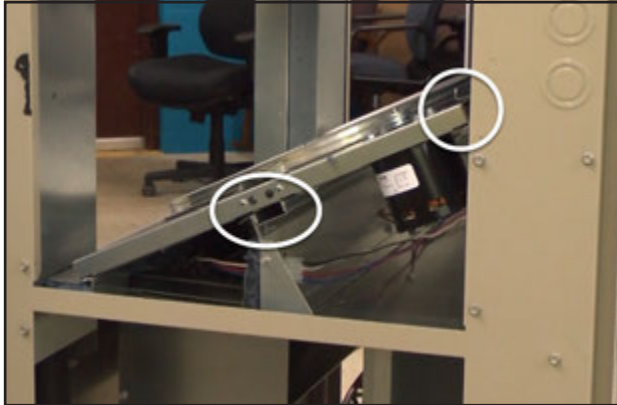

Install the 4-pin female plug into the cutout in the control panel (see Figure 35). Following the wiring diagram, connect the white wire from the plug to the terminal block.

FIGURE 35
Install 4-Pin Female Plug and Connect White Wire

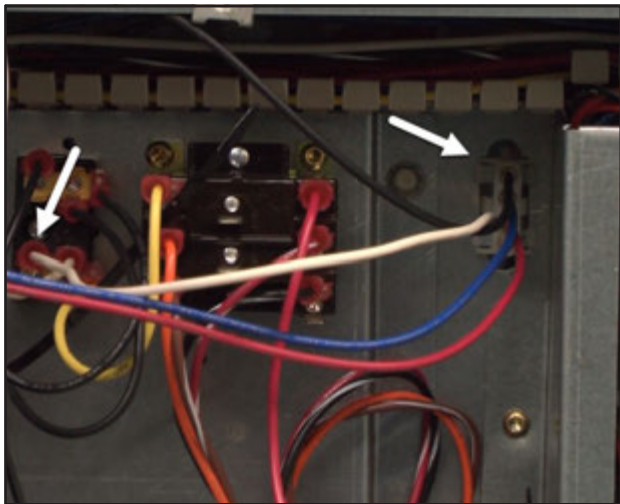

Connect the 4-pin male plug from the upper blower assembly into the 4-pin female plug through the back of the control panel (see Figure 36).

FIGURE 36
Connect Male Plug to Female Plug

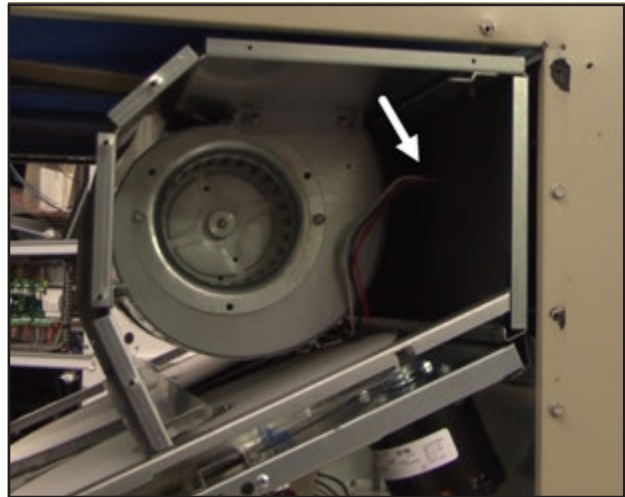

Non-W*VHY Models

Route the red and black wires from the ERV control board through the wire troughs and to the compressor contactor (see Figure 37). Following the wiring diagram, connect the black wire to L2 and the red wire to L1.

FIGURE 37
Route Red and Black Wires to Compressor Contactor (Non-W*VHY Models)

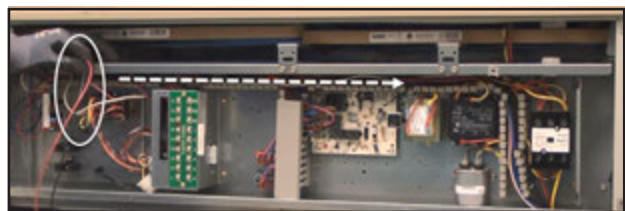

W*VHY Models

ERV-FA5 230V: Route the red and black wires from the ERV control board through the wire troughs and to the power distribution block (see Figure 38).

ERV-FT5 460V: Route the red and black wires to the 230V terminal block found in the upper right side of the control panel. Label should be near the appropriate terminal block (see Figure 38).

FIGURE 38
Route Red and Black Wires (W*VHY Models)

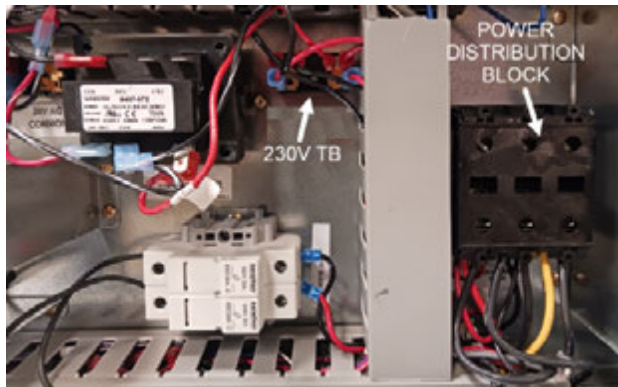

W*VHY Models

Following the wire diagram, connect brown wire #94 from PLC to relay as shown in Figure 39. Connect black wire #31 from relay to 24v Common terminal block found in upper right side of control panel in Figure 40.

FIGURE 39
ERV Relay Com and 24V Wire(s)
(W*VHY Models)

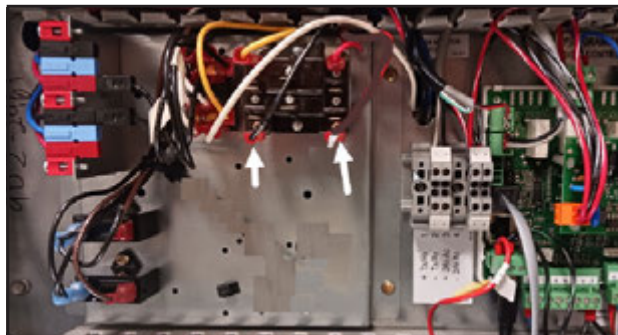
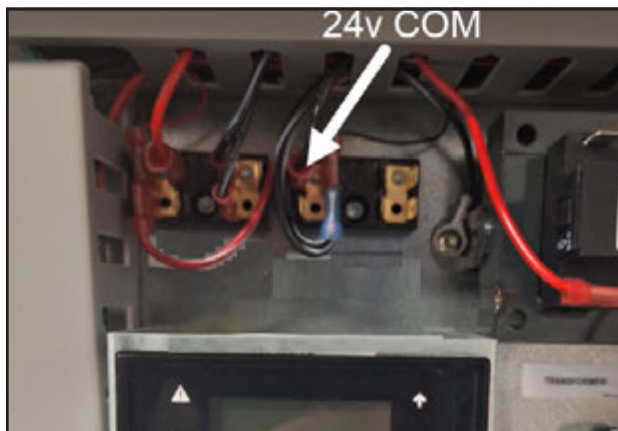

FIGURE 40
ERV Relay Com Wire Landing
(W*VHY Models)



See Figure 41 and the following steps for instructions on connecting the cassette wire harnesses.

Connect both 4-pin male cassette wire harnesses into the 4-pin female plugs. Connect both green ground wires to the sheet metal using a provided screw (see Figure 41).

FIGURE 41
Connect Cassette Wire Harnesses and Ground Wires

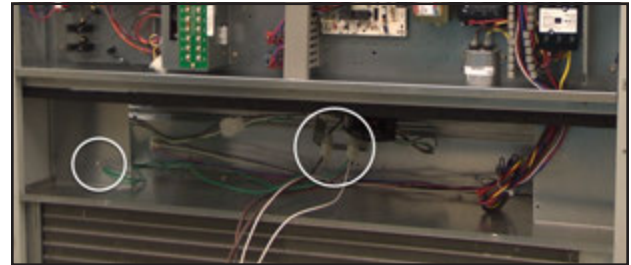

Starting with one of the cassette wire harnesses, feed the wires up into the control panel (using the opening below the compressor contactor) and through the troughs to the ERV control board (see Figure 42). Routing the harnesses separately will help prevent crossing wires between the two motor circuits.

FIGURE 42
Route First Wire Harness Wires Up into
Control Panel

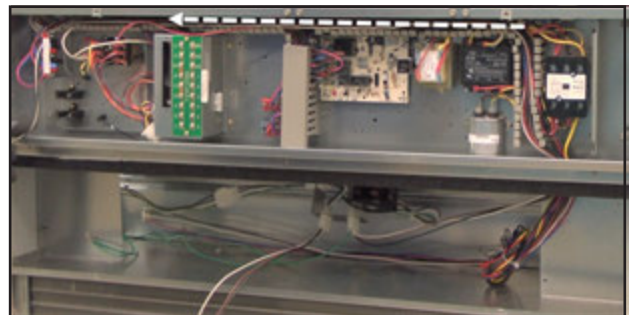

Following the wiring diagram, connect the brown and black wires to one of the capacitors and the black wire to the top of the terminal block (see Figure 43 on page 16). Repeat this process for the second set of wires. Once completed, re-install the wire trough covers.

FIGURE 43
Connect Wires to Capacitor and Terminal Block

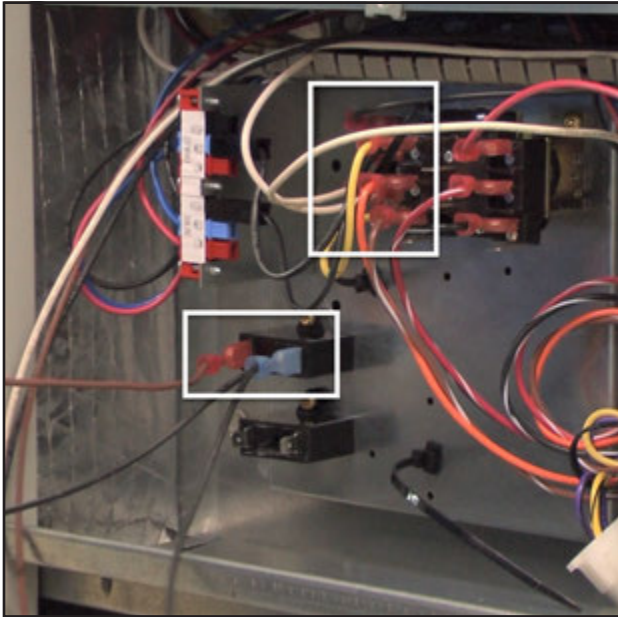

The wiring is now completed. Use the provided wire ties to bundle and secure loose wires.

CAUTION: Do not allow wires to rub on any moving parts.

Figure 44 shows the cassette seal adjustment angle.

FIGURE 44
Cassette Seal Adjustment Angle

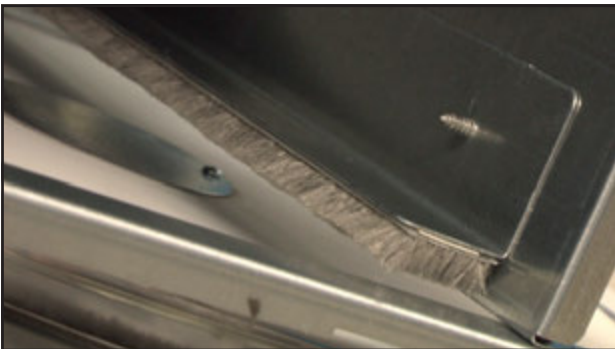

The two (2) screws (one per side) can be loosened to allow the pile seal to brush against the cassettes (see Figure 45).

FIGURE 45
Loosen Screws to Adjust Pile Seal

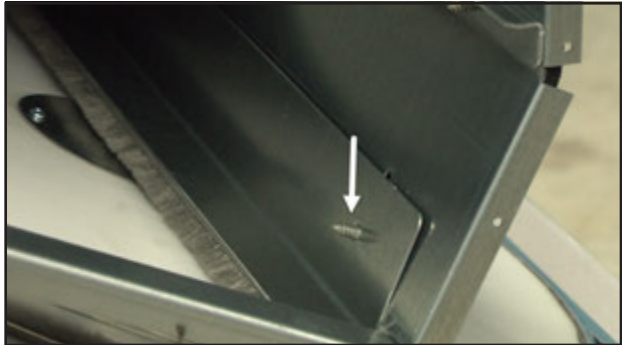

Install the upper side covers (one per side) using 11 screws each (see Figure 46).

FIGURE 46
Install Upper Side Covers

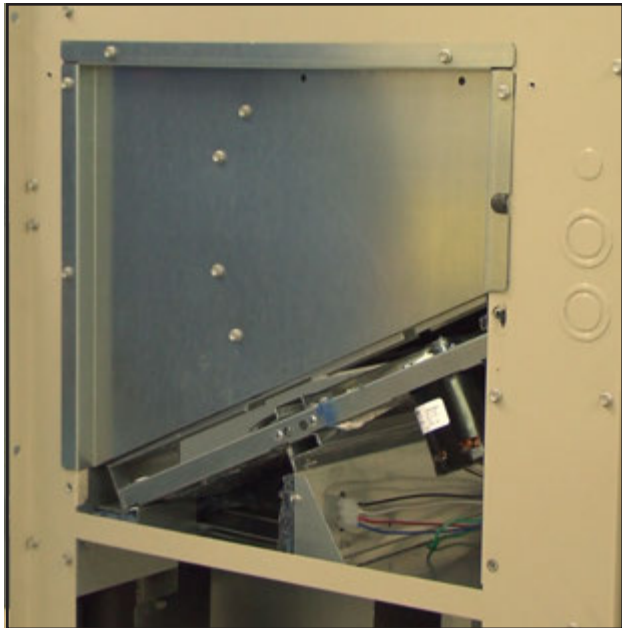

Install the lower side covers (one per side) using four (4) screws each (see Figure 47).

FIGURE 47
Install Lower Side Covers



Install two (2) 1913-002-0808 foam gaskets to sides of cabinet (see Figure 48). Install the 7003-083 exhaust bug screen.

FIGURE 48
Install Bug Screen and Gaskets

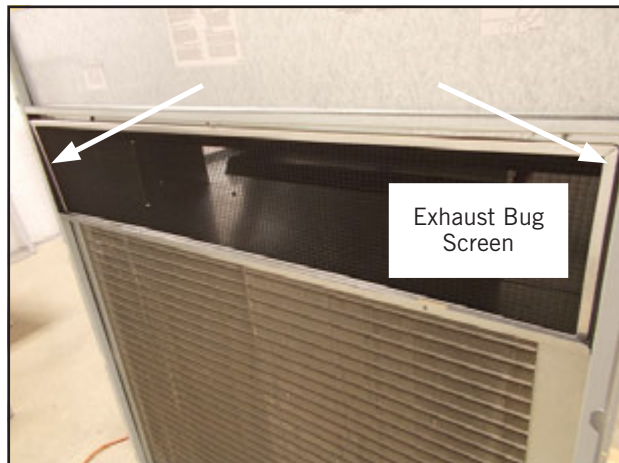

Re-install all front panels and both side grilles.
Restore power to unit.

Control Wiring

The ERV-F comes from the factory with the low voltage control wires connected to the wall mount low voltage terminal strip. Care must be taken when deciding how to control the operation of the ventilator. When designing the control circuit for the ventilator, the following requirements must be met.

Control Requirements

1. Indoor blower motor will automatically run whenever the ERV-F is running.
2. Select the correct motor speed tap in the ERV-F. Using Table 2, determine the motor speed needed to get the desired amount of ventilation air needed. For instance, do not use the high speed tap on a ERV-F*5 if only 300 CFM of ventilation air is needed. Use the low speed tap instead (see **Ventilation Airflow** on page 18 for information on moving the speed taps). Using the high speed tap would serve no useful purpose and significantly affect the overall efficiency of the air conditioning system. System operating cost would also increase.

TABLE 2
Ventilation Air (CFM)

Model	High Speed (Black)	Medium Speed (Blue)	Low Speed (Red)
ERV-FA5	480	400	300
ERV-FC5			
ERV-FT5			

3. Run the ERV-F only during periods when the conditioned space is occupied. Running the ERV-F during unoccupied periods wastes energy, decreases the expected life of the ERV-F and can result in a large moisture buildup in the structure. The ERV-F removes 60-70% of the moisture in the incoming air, not 100% of it. Running the ERV-F when the structure is unoccupied allows moisture to build up in the structure because there is little or no cooling load. Thus, the air conditioner is not running enough to remove the excess moisture being brought in. Use a control system that in some way can control the system based on occupancy.

IMPORTANT

Operating the ERV-F during unoccupied periods can result in a buildup of moisture in the structure.

Recommended Control Sequences

Several possible control scenarios are listed below:

1. Use a programmable electronic thermostat with auxiliary terminal to control the ERV-F based on daily programmed occupancy periods. Bard markets and recommends Bard Part No. 8403-060 programmable electronic thermostat for air conditioner and heat pump applications.
2. Use a motion sensor in conjunction with a mechanical thermostat to determine occupancy in the structure. Bard recommends Bard Model CS9B*-.**** CompleteStat for this application.
3. Use a CO₂ control with dry contacts to energize the ERV-F when CO₂ levels rise above desired settings.
4. Use a DDC control system to control the ERV-F based on a room occupancy schedule to control the ERV-F.
5. Tie the operation of the ERV-F into the light switch. The lights in a room are usually on only when occupied.
6. Use a manual timer that the occupants turn to energize the ERV-F for a specific number of hours.
7. Use a programmable mechanical timer to energize the ERV-F and indoor blower during occupied periods of the day.

Ventilation Airflow

The ERV-FA*, ERV-FC* and ERV-FT* are equipped with a 3-speed motor to provide the capability of adjusting the ventilation rates to the requirements of the specific application by changing motor speeds (see Table 2 on page 4).

WARNING

Open disconnect to shut all power OFF before changing motor speeds. Failure to do so could result in injury or death due to electrical shock.

The units are set from the factory with the exhaust blower on the low speed and the intake blower on medium speed. Moving the speed taps located in the control panel can change the blower speed of the intake and exhaust (see Figure 49).

FIGURE 49
Speed Tap Label

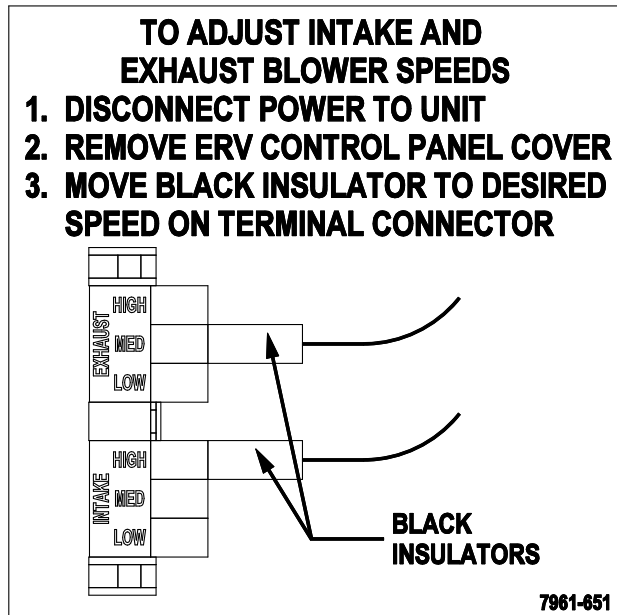

MIS-2120

FIGURE 50
Airflow Diagram

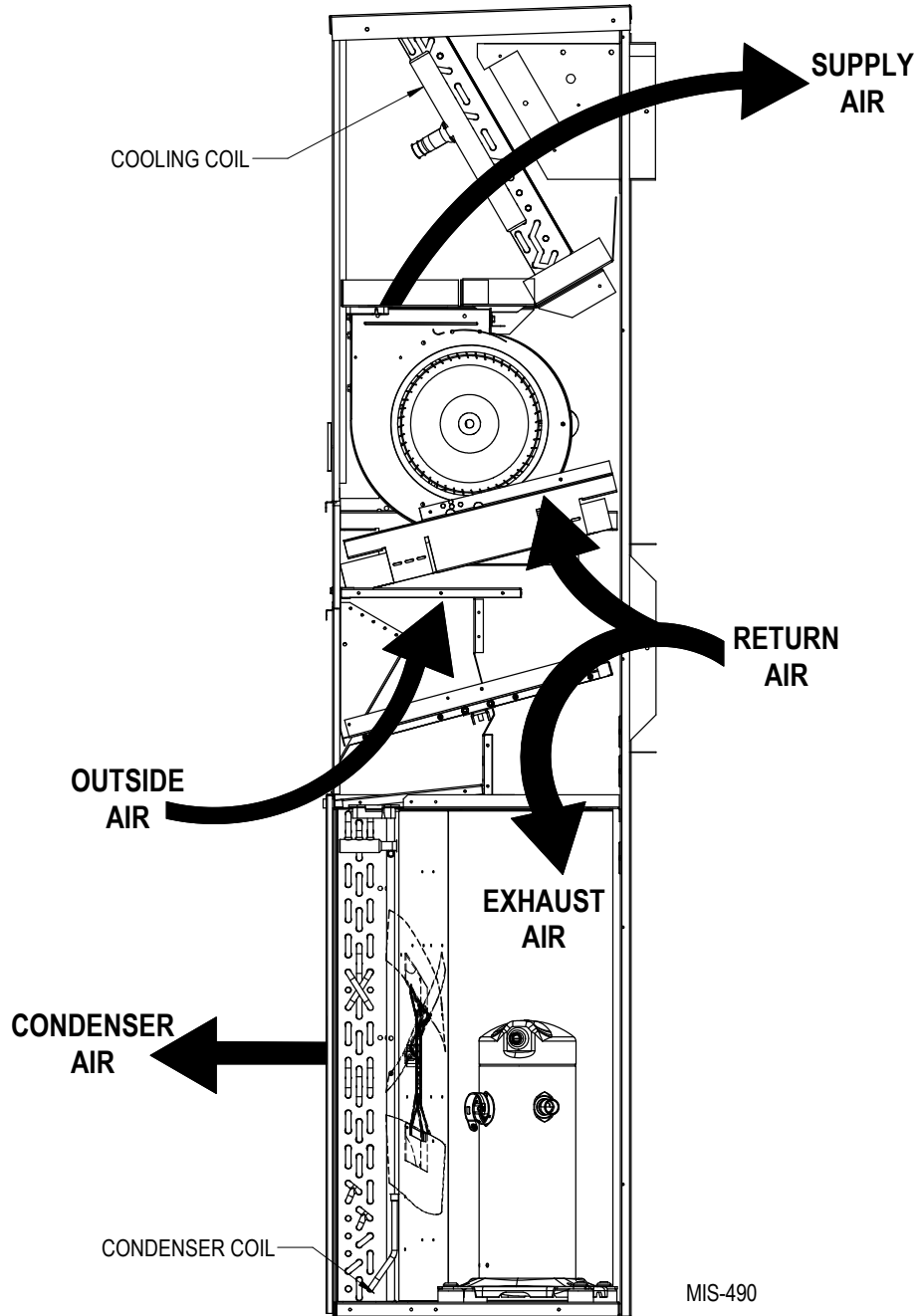

ENERGY RECOVERY VENTILATOR MAINTENANCE

General Information

The ability to clean exposed surfaces within air moving systems is an important design consideration for the maintenance of system performance and air quality. The need for periodic cleaning will be a function of operating schedule, climate and contaminants in the indoor air being exhausted and in the outdoor air being supplied to the building. All components exposed to the airstream, including energy recovery wheels, may require cleaning in most applications.

Rotary counterflow heat exchangers (heat wheels) with laminar airflow are “self-cleaning” with respect to dry particles. Smaller particles pass through; larger particles land on the surface and are blown clear as the flow direction is reversed. For this reason, the primary need for cleaning is to remove films of oil-based aerosols that have condensed on energy transfer surfaces. Buildup of material over time may eventually reduce airflow. Most importantly, in the case of desiccant-coated (enthalpy) wheels, such films can close off micron-sized pores at the surface of the desiccant material, reducing the efficiency with which the desiccant can absorb and desorb moisture.

Frequency

In a reasonably clean indoor environment such as a school, office building or home, experience shows that reductions of airflow or loss of sensible (temperature) effectiveness may not occur for 10 or more years. However, experience also shows that measurable changes in latent energy (water vapor) transfer can occur in shorter periods of time in commercial, institutional and residential applications experiencing moderate occupant smoking or with cooking facilities. In applications experiencing unusually high levels of occupant smoking, such as smoking lounges, nightclubs, bars and restaurants, washing of energy transfer surfaces, as frequently as every 6 months, may be necessary to maintain latent transfer efficiency. Similar washing cycles may also be appropriate for industrial applications involving the ventilation of high levels of smoke or oil-based aerosols such as those found in welding or machining operations, for example. In these applications, latent efficiency losses of as much as 40% or more may develop over a period of 1 to 3 years.

Cleanability and Performance

In order to maintain energy recovery ventilation systems, energy transfer surfaces must be accessible for washing to remove oils, grease, tars and dirt that can impede performance or generate odors. Washing of the desiccant surfaces is required to remove contaminate buildups that can reduce absorption of

water molecules. The continued ability of an enthalpy wheel to transfer latent energy depends upon the permanence of the bond between the desiccant and the energy transfer surfaces.

Bard wheels feature silica gel desiccant permanently bonded to the heat exchange surface without adhesives; the desiccant will not be lost in the washing process. Proper cleaning of the Bard energy recovery wheel will restore latent effectiveness to near original performance.

Maintenance Procedures

NOTE: *Local conditions can vary and affect the required time between routine maintenance procedures; therefore, all sites (or specific units at a site) may not have the same schedule to maintain acceptable performance. The following timetables are recommended and can be altered based on local experience.*

Quarterly Maintenance

1. Inspect bug screen/prefilter and clean if necessary. This filter is located behind the front condenser grille. This is a nonmetallic filter and can be cleaned with soap and water only.
2. Inspect wall mount unit filters and clean or replace as necessary. These filters are located either in the unit, in a return air filter grille assembly or both. If in the unit they can be accessed by removing the front control panel on the front of the unit. If in a return air filter grille, hinge the grille open to gain access.
3. Inspect energy recovery ventilator for proper wheel rotation and dirt buildup. This can be done in conjunction with Item 2 above. Energize the energy recovery ventilator after inspecting the filter and observe for proper rotation and/or dirt buildup.
4. Recommended energy recovery wheel cleaning procedures follow: Disconnect all power to unit. Remove the front condenser grill and left or right side condenser grille of the wall mount unit to gain access to the energy recovery ventilator.
5. Remove the upper and lower side covers. Unplug amp connectors to cassette motors. Slide energy recovery cassette out of ventilator.
6. Use a shop vacuum with brush attachment to clean both sides of the energy recovery wheels.
7. Reverse shop vacuum to use as a blower and blow out any residual dry debris from the wheel.

NOTE: *Discoloration and staining of the wheel does not affect its performance. Only excessive buildup of foreign material needs to be removed.*

8. If any belt chirping or squealing noise is present, apply a small amount of LPS-1 or equivalent dry film lubricant to the belt.

Annual Maintenance

1. Inspect and conduct the same procedures as outlined under **Quarterly Maintenance**.
2. To maintain peak latent (moisture) removal capacity, it is recommended that the energy recovery wheels be sprayed with a diluted nonacid-based evaporator coil cleaner or alkaline detergent solution such as 409.

NOTE: Do not use acid-based cleaners, aromatic solvents, temperatures in excess of 170°F or steam. Damage to the wheel may result.

Do not disassemble and immerse the entire heat wheel in a soaking solution, as bearing and other damage may result.

3. Rinse wheel thoroughly after application of the cleaning solution and allow to drain before re-installing.
4. No re-lubrication is required to heat wheel bearings of the drive motor, or to the intake and exhaust blower motors.
5. If any belt chirping or squealing noise is present, apply a small amount of LPS-1 or equivalent dry film lubricant to the belt.

Figure 51
Belt Replacement Instructions

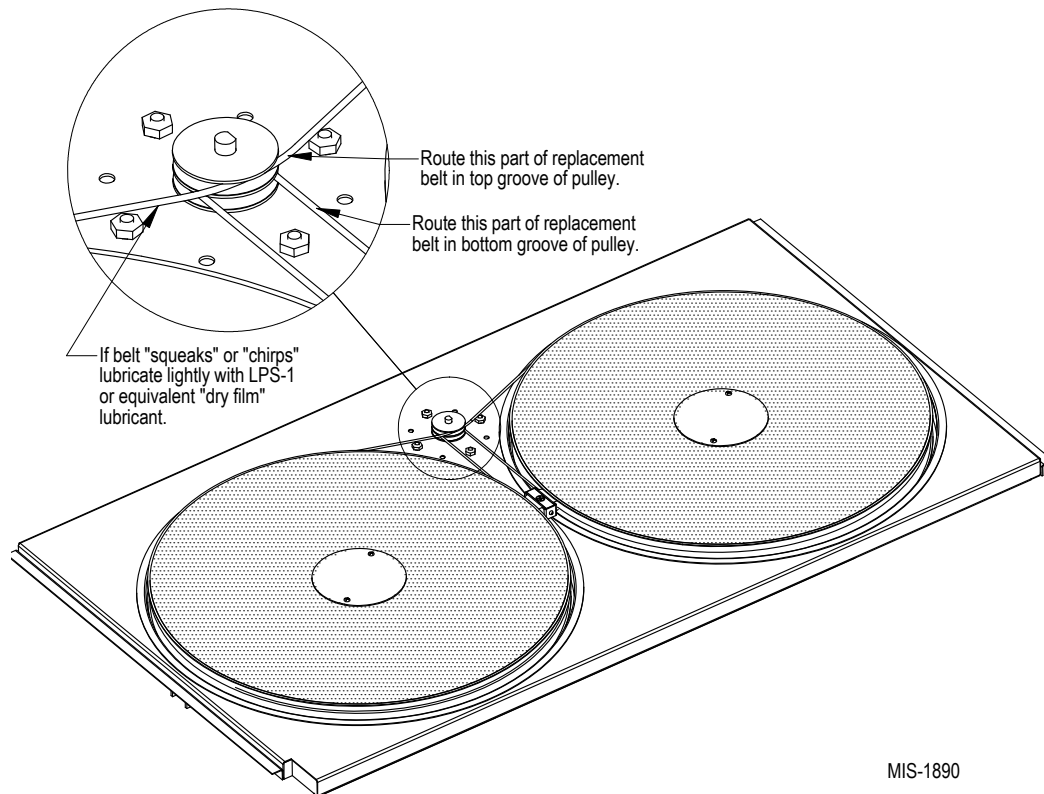

MIS-1890

FIGURE 52
Hub Assembly with Ball Bearings

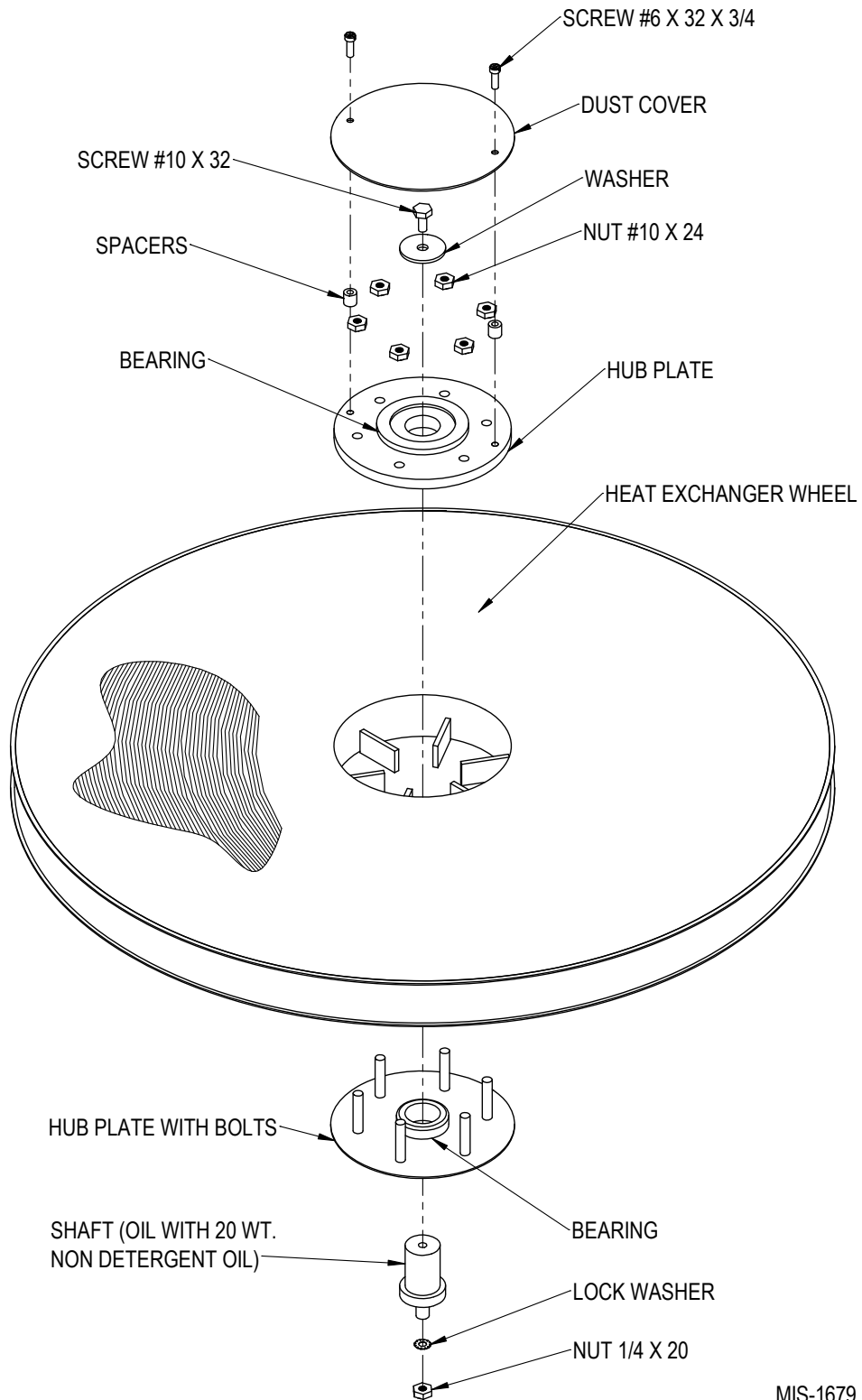

MIS-1679

FIGURE 53
Wire Routings (Non-W*VHY Models)

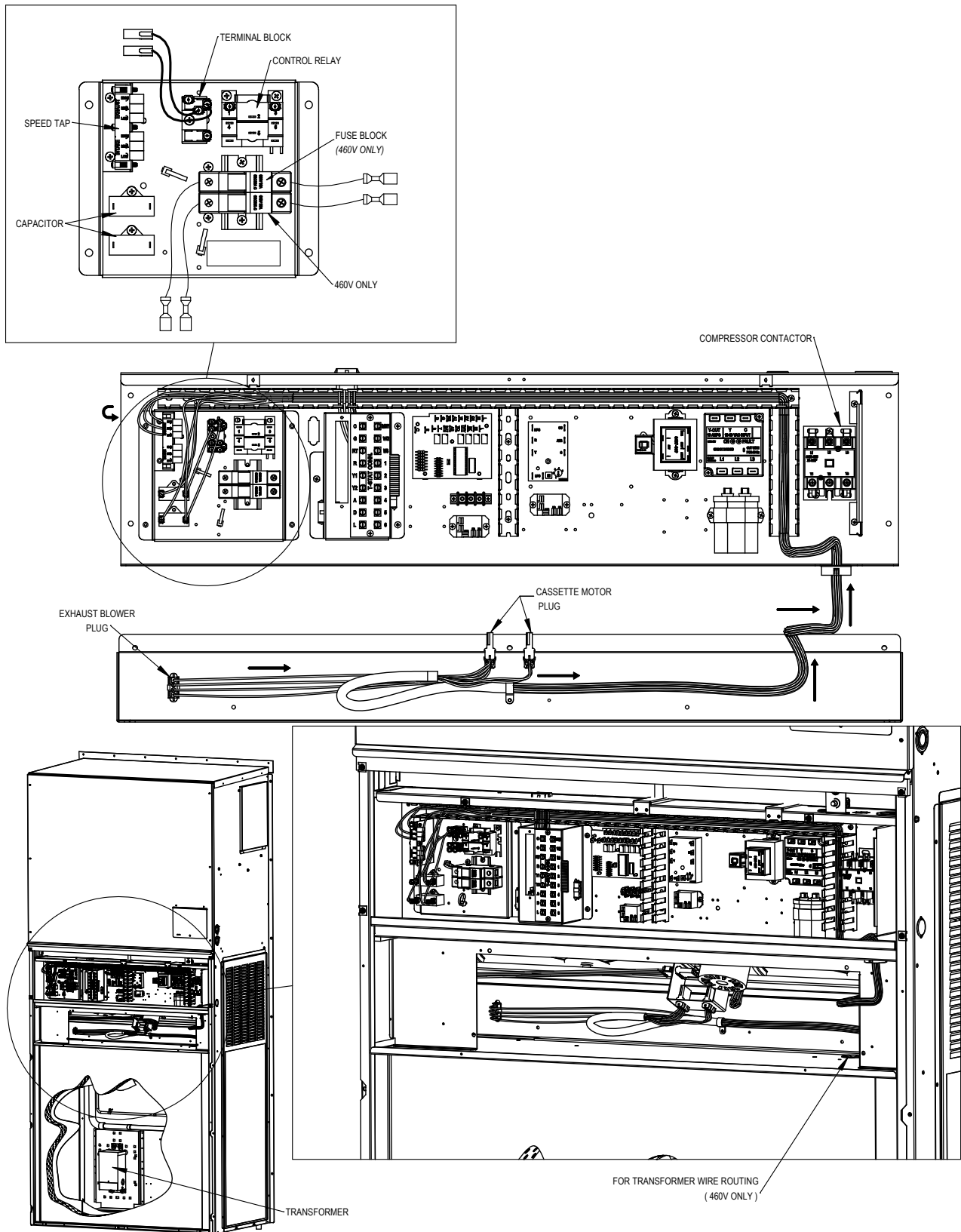

MIS-4048

FIGURE 54
Wire Routings (W*VHY Models)

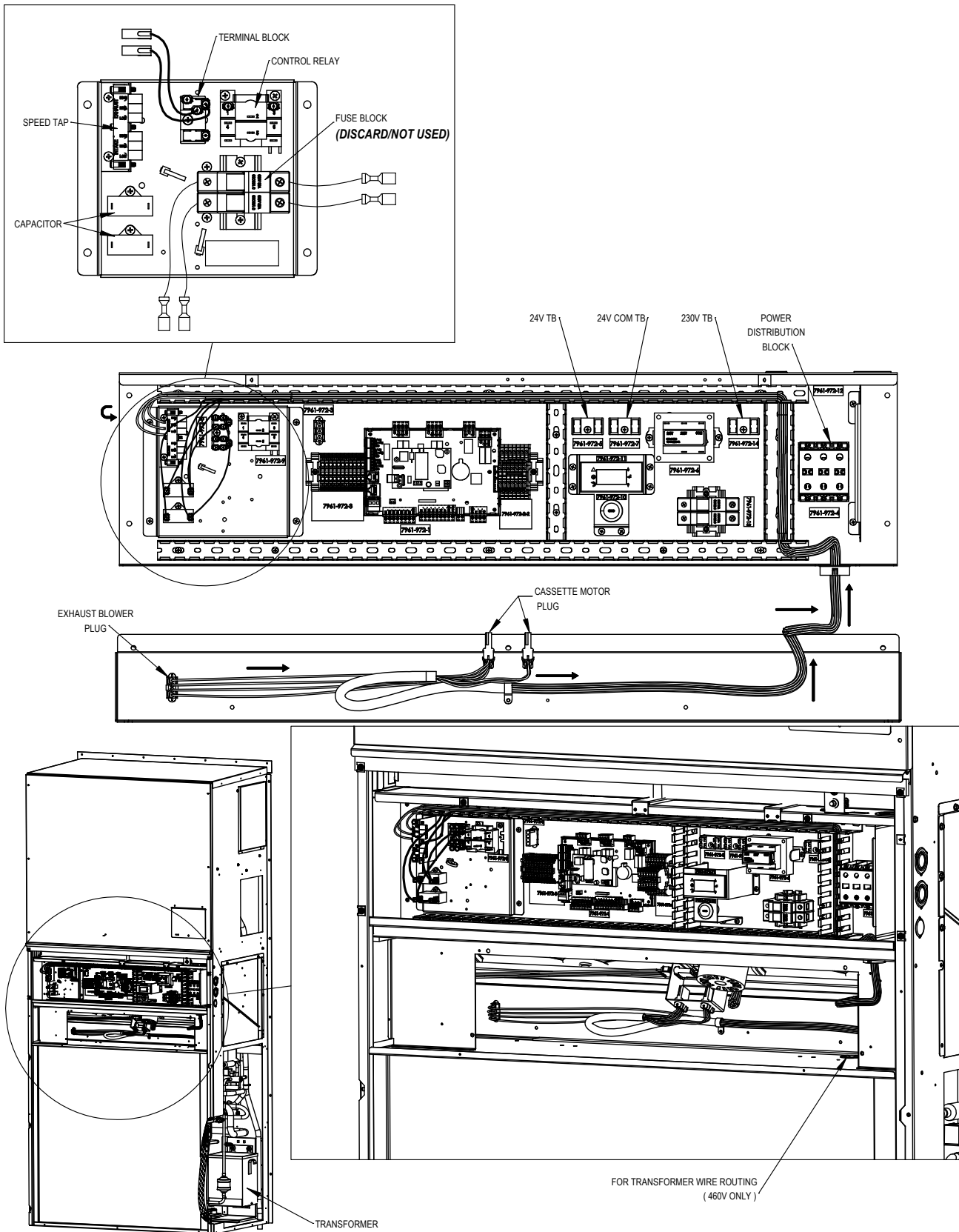

MIS-4470

FIGURE 55
Transformer Mounting and Wire Routing (ERV-FC5 460V Only)

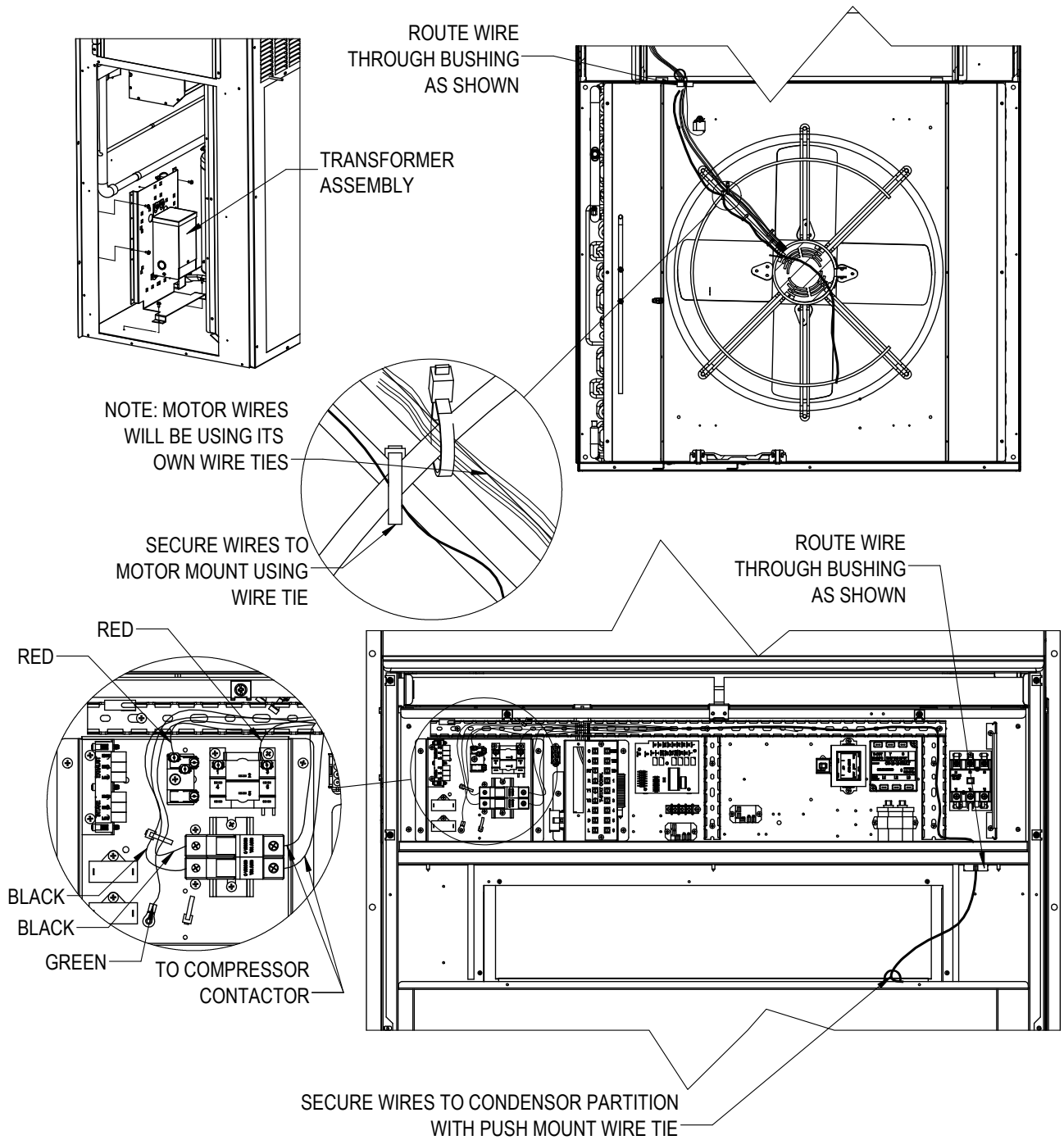

mis-4050

FIGURE 56
Transformer Mounting and Wire Routing (ERV-FT5 460V Only)

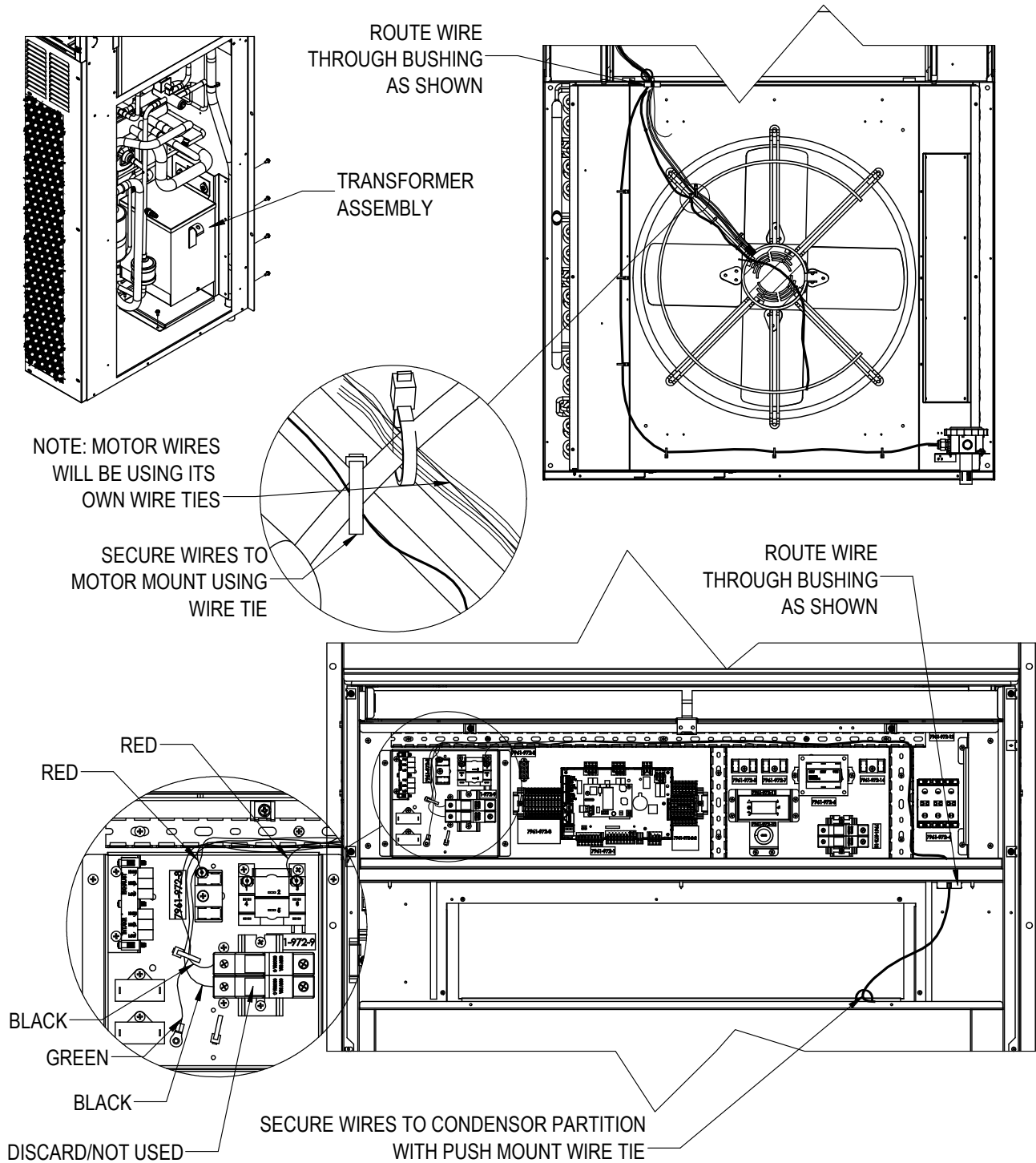

MIS-4471

FIGURE 57
ERV-FA5 230V Wiring Diagram (Non-W*VHY Models)

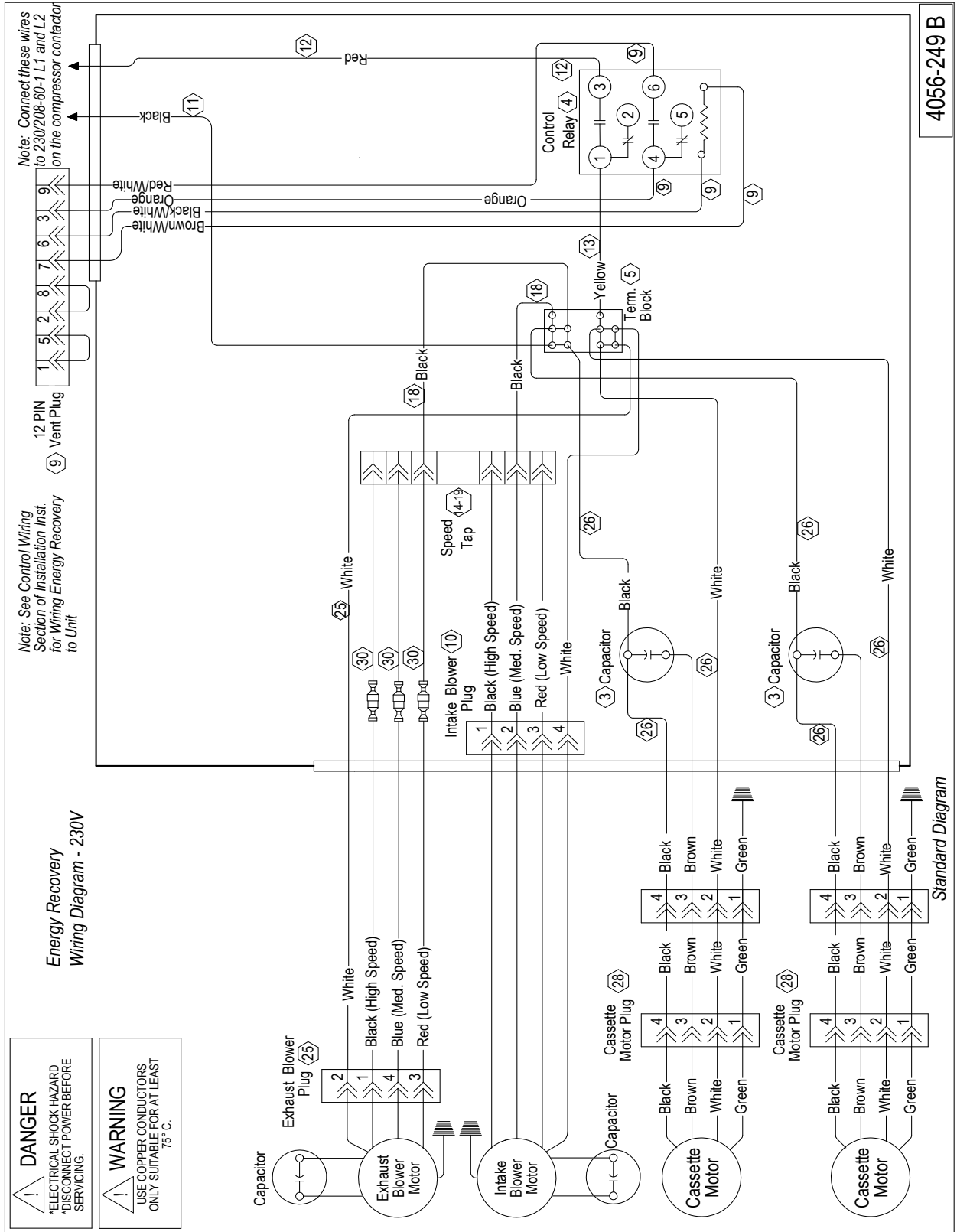

FIGURE 58
ERV-FA5 230V Wiring Diagram (W*VHY Models)

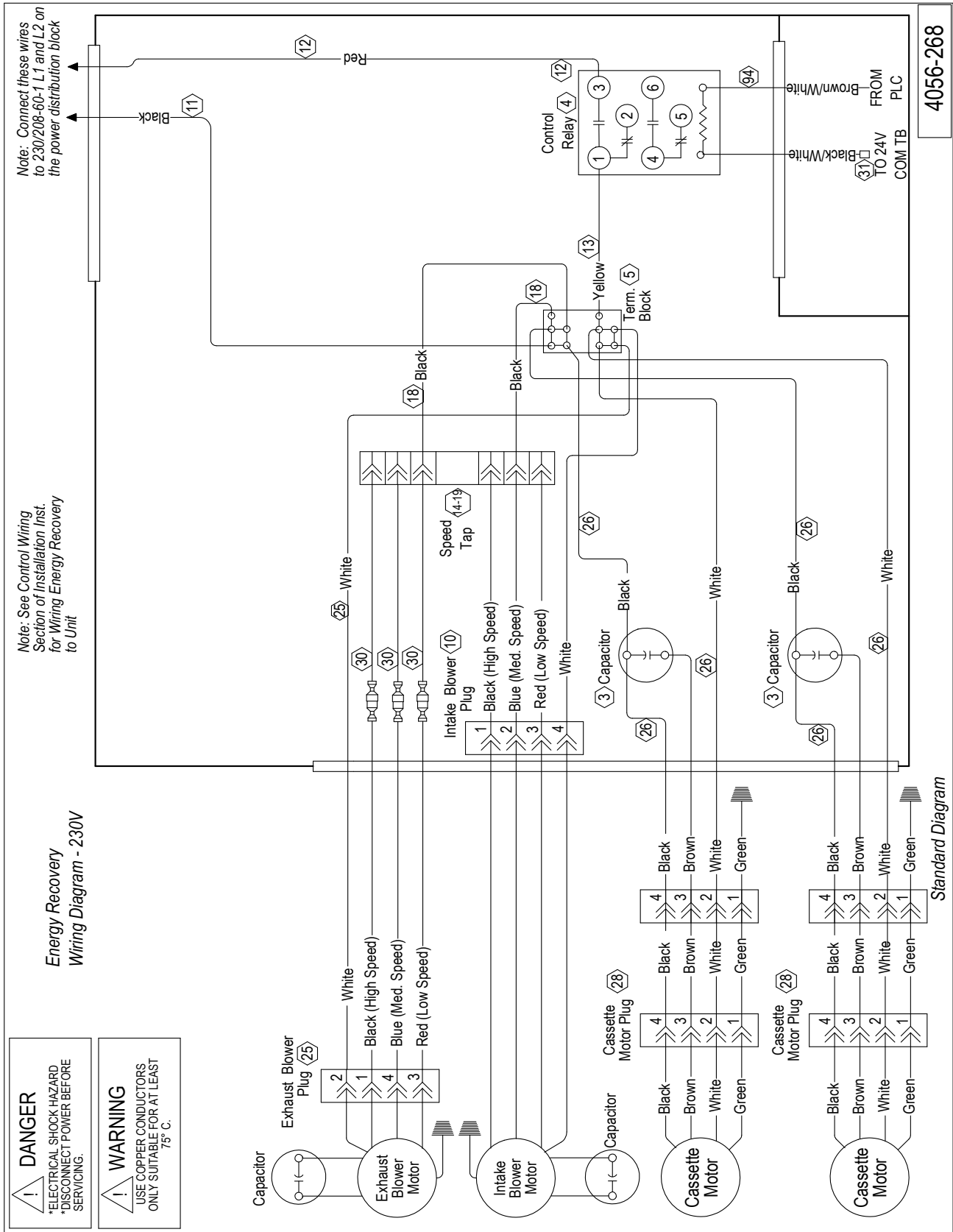
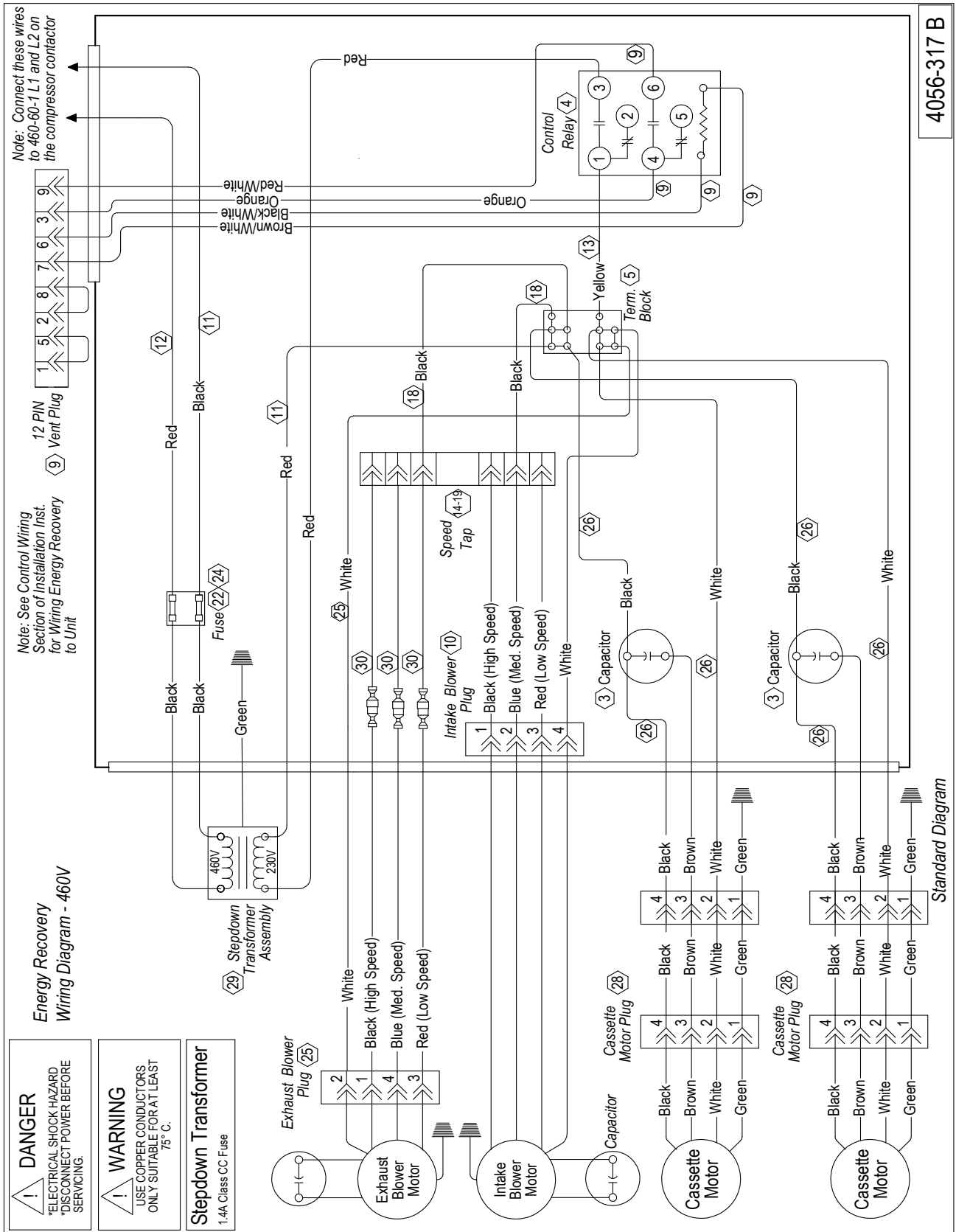

FIGURE 59
ERV-FC5 460V Wiring Diagram (Non-W*VHY Models)



4056-317 B

Standard Diagram

FIGURE 60
ERV-FA5 460V Wiring Diagram (Non-W*VHY Models)

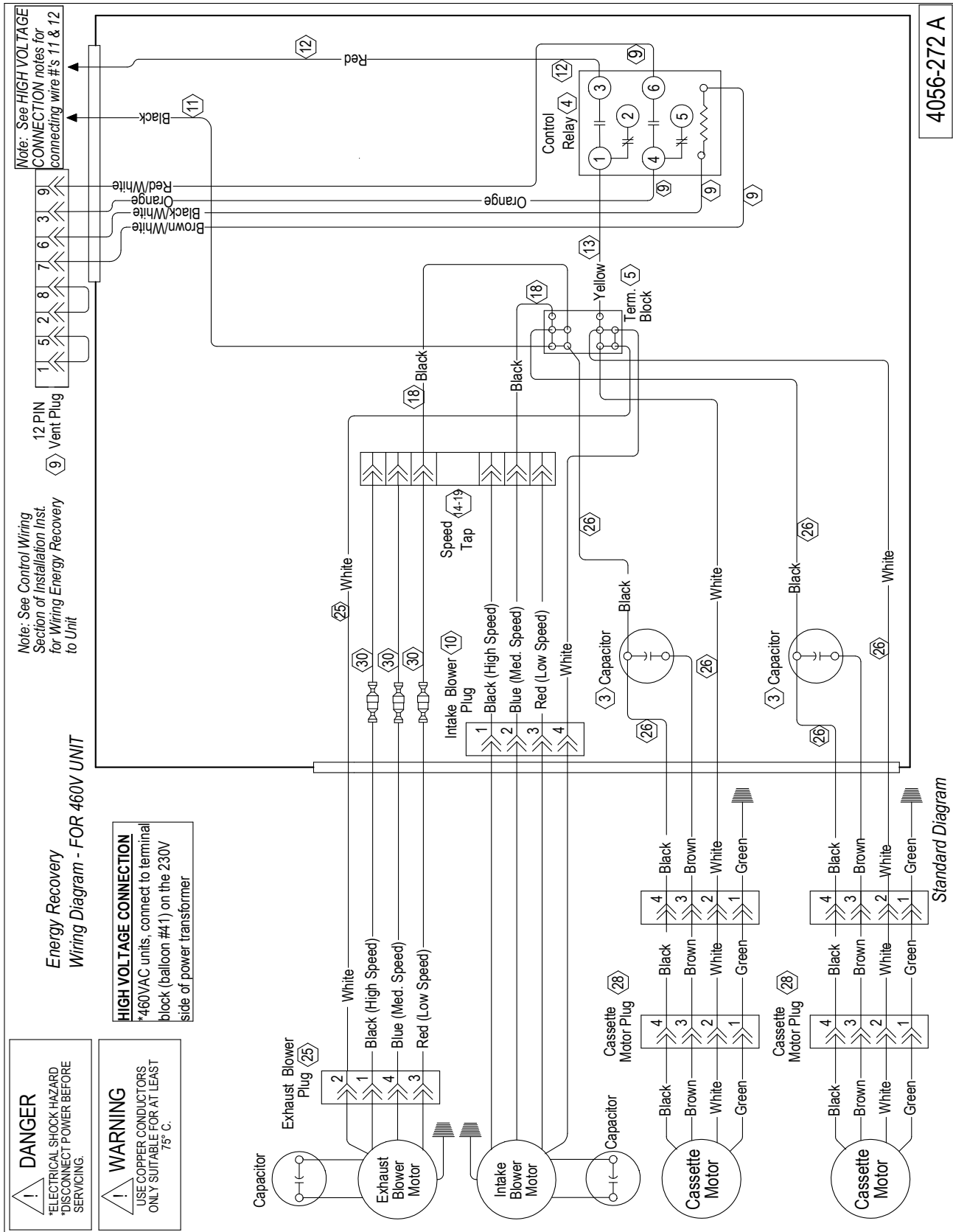

4056-272 A

FIGURE 61
ERV-FT5 460V Wiring Diagram (W*VHY Models)

